

Balancing Authority Requirements and Responsibilities

Utility Wind Interest Group

April 12, 2005



The Control Area

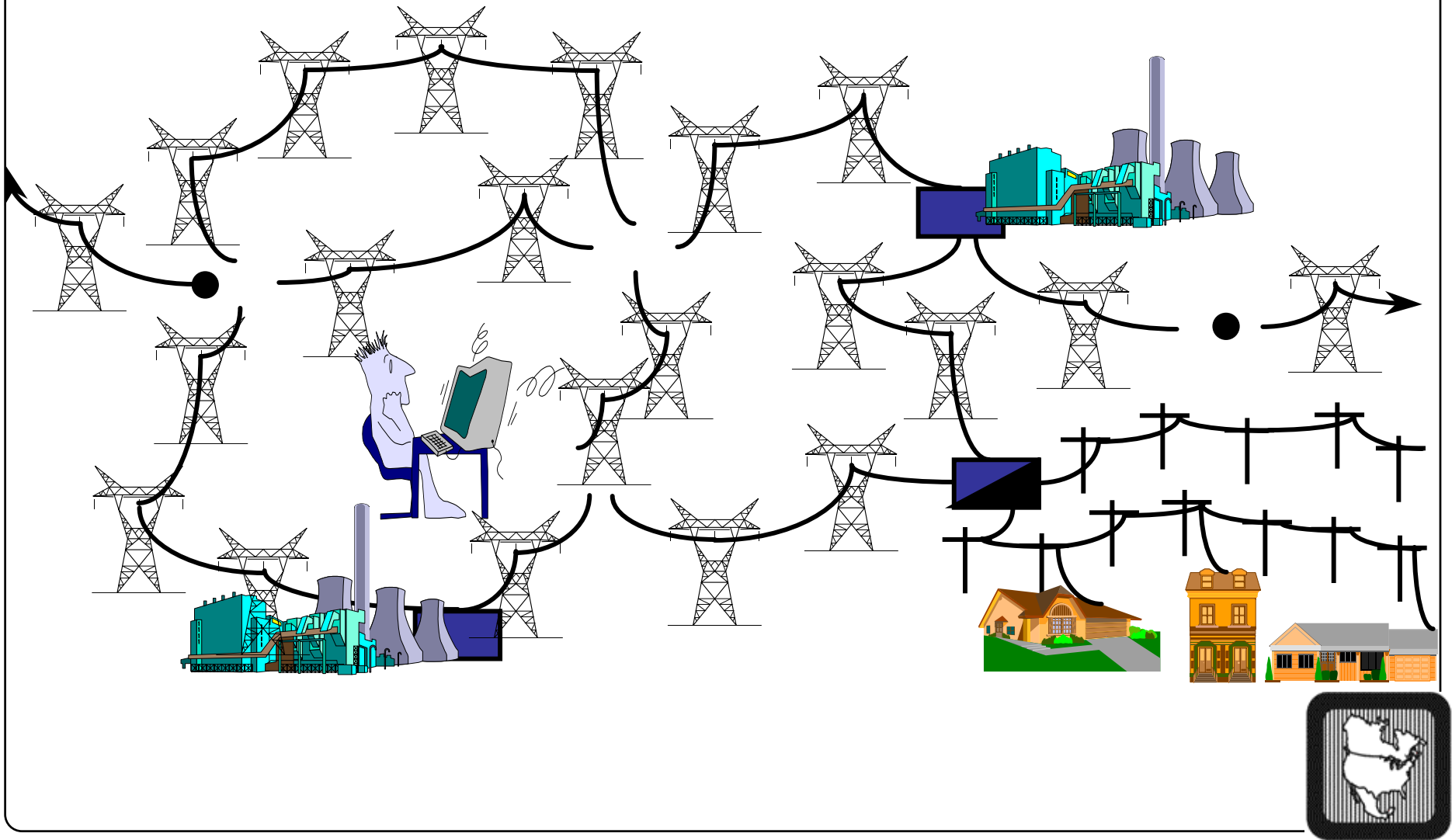

Historically: Vertically Integrated

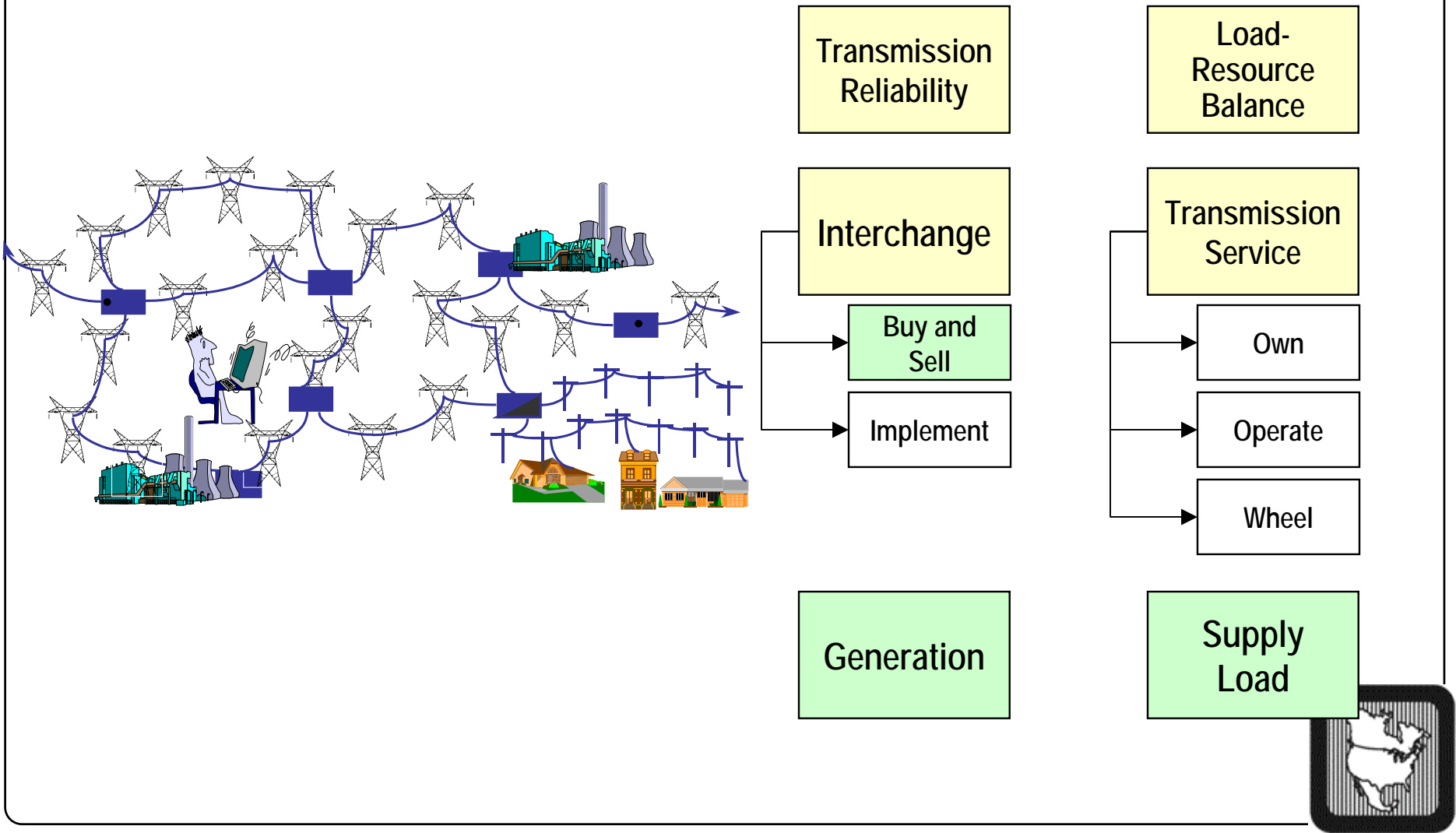

Today: Parts and Pieces

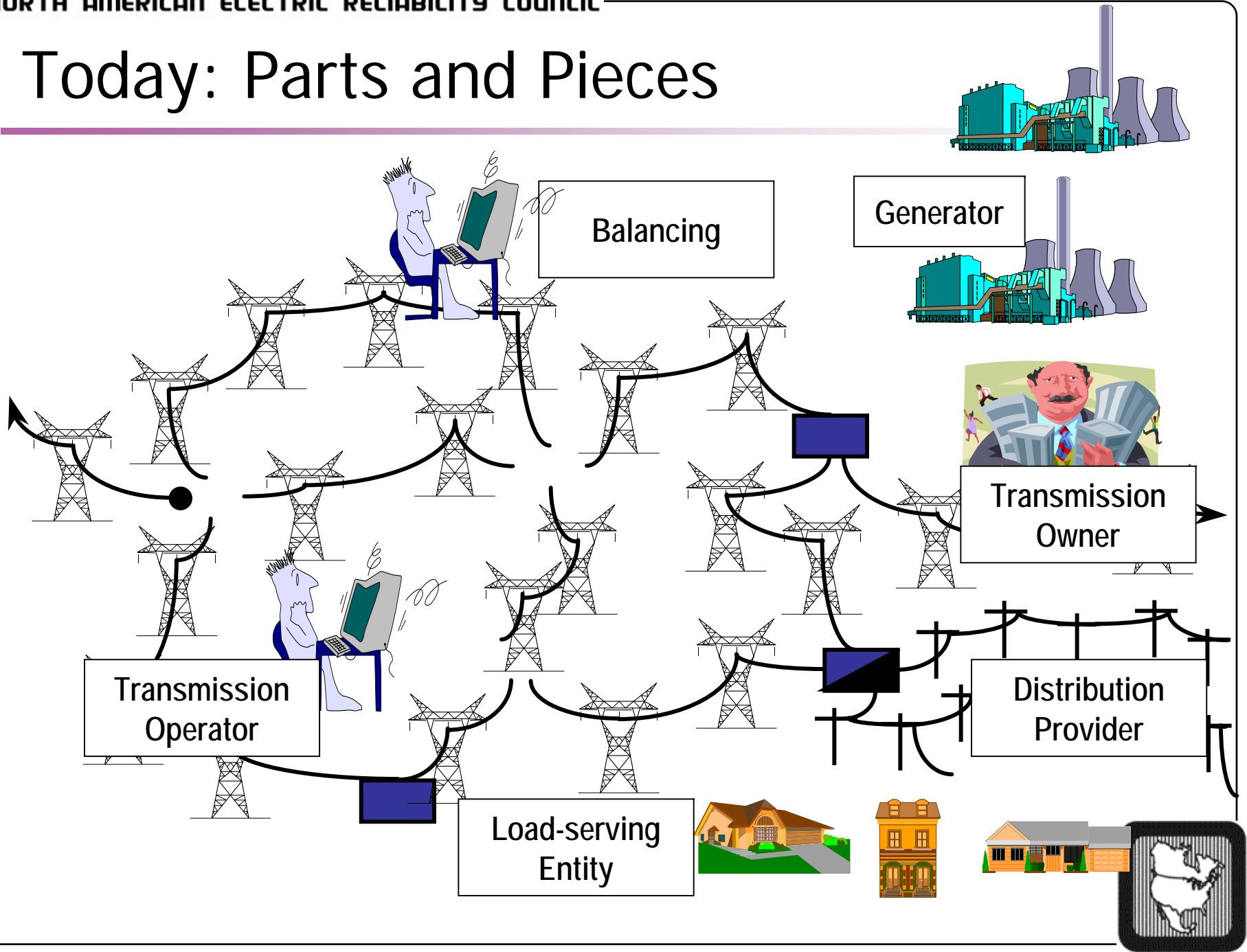

What do we do now?

- Control Area is no longer the basic operating organization
 - NERC Operating Policies do not reflect the new organizations or merchant functions that are forming
 - Need to define the basic functions and “roll up” into organizations
- ITPs
 - RTOs
 - ITCs
 - Reliability
 - Balancing
 - Interchange
 - Transmission

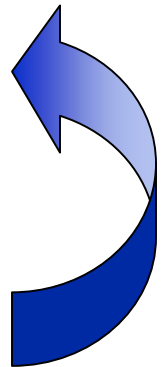

The Functional Model

1. **List** every reliability task we could think of
2. **Group** into Functions
3. **Assign** to Responsible Entities
 - Invent new names as needed
 - Set up relationships

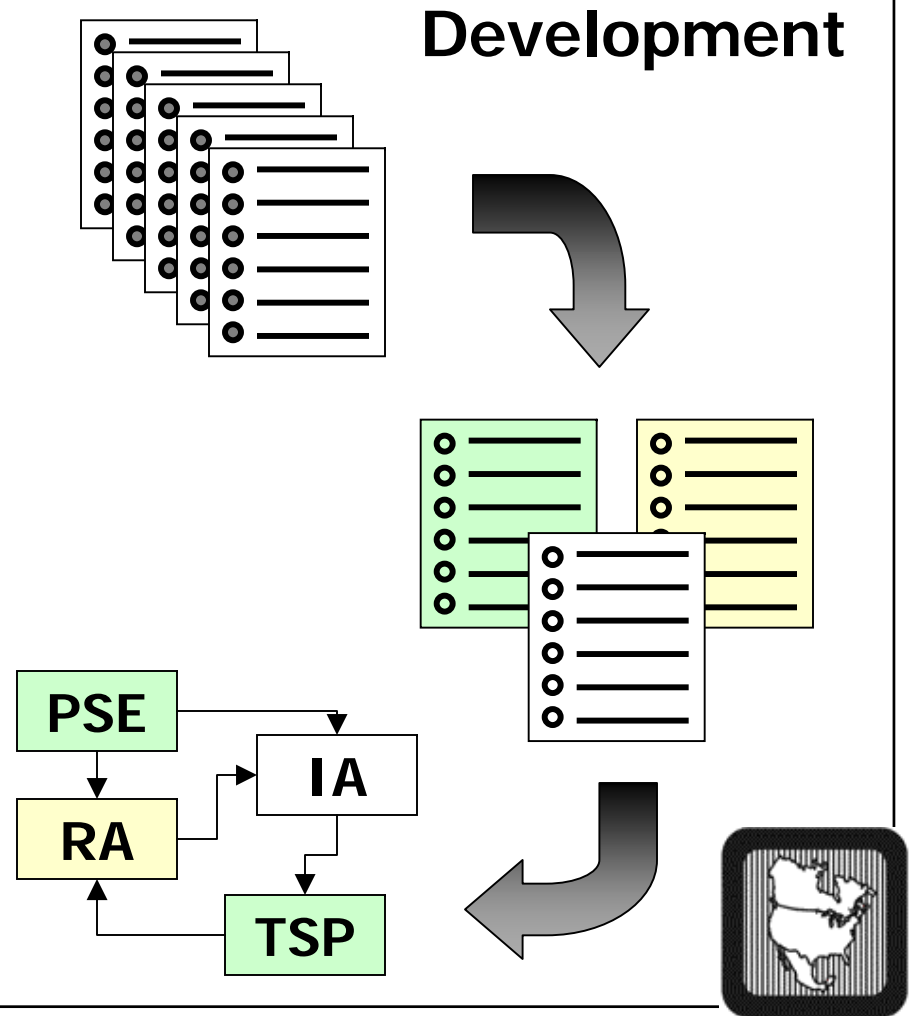

The Functional Model

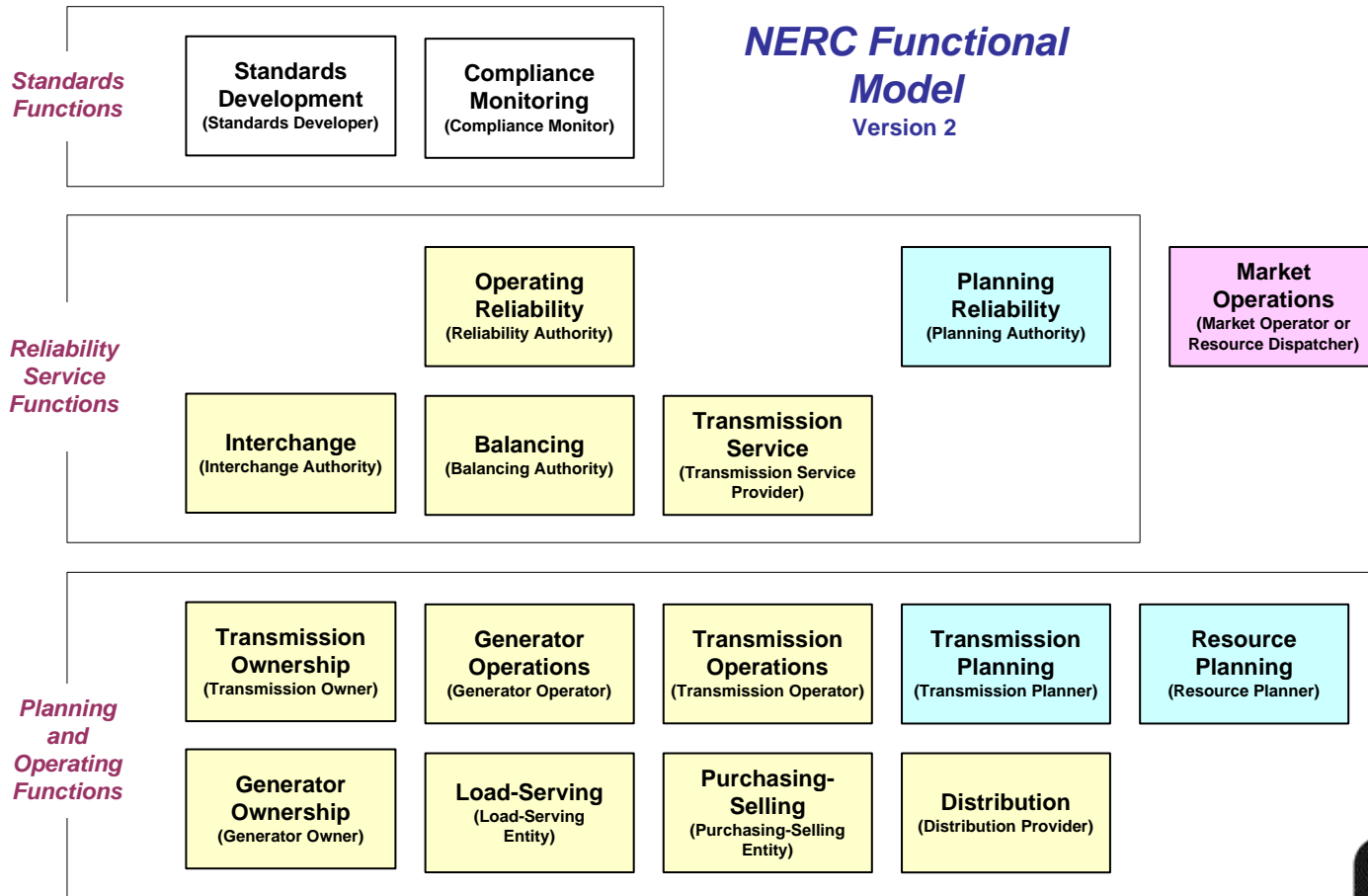

Questions?



"Rolling Up" into Organizations

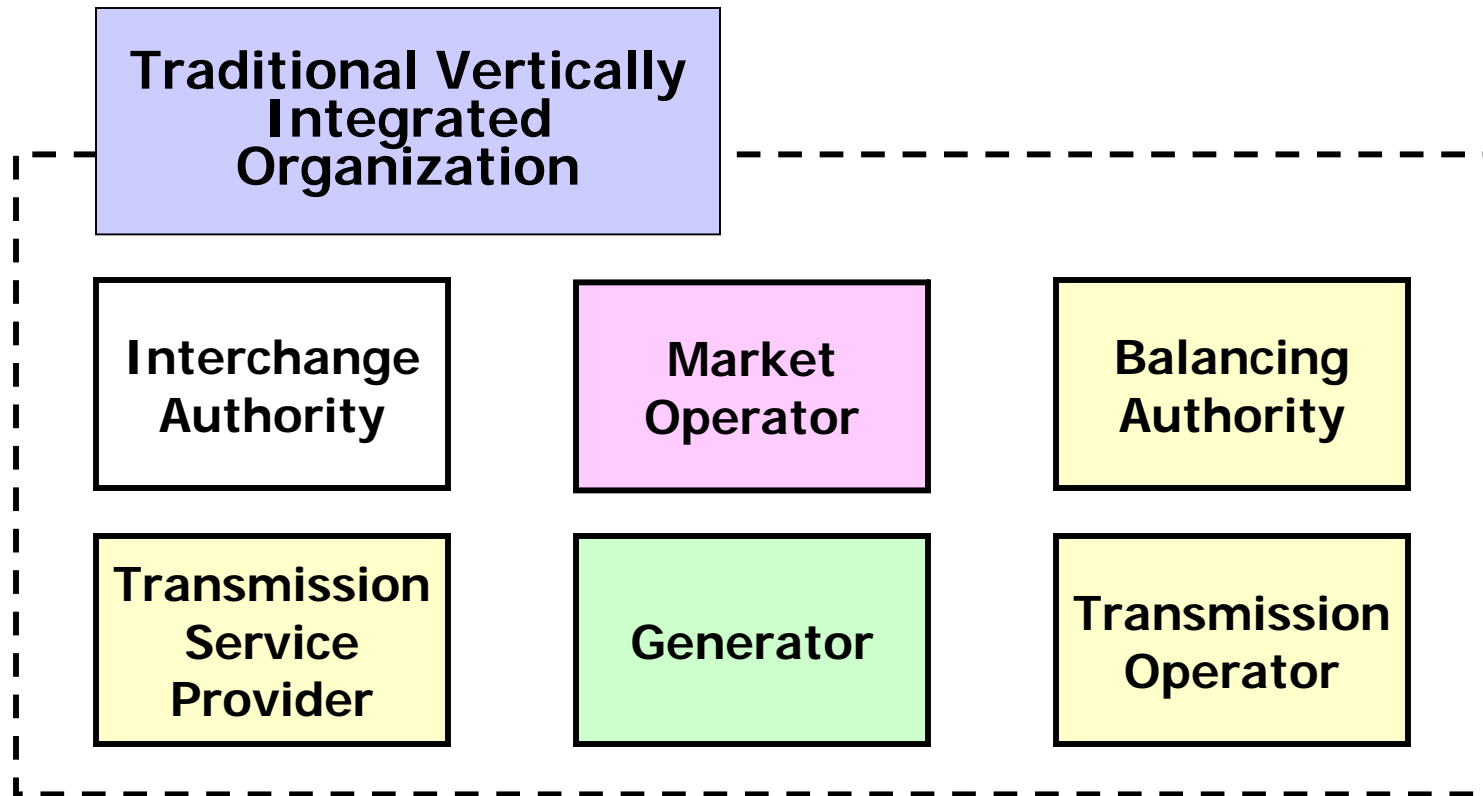

"Rolling Up" into Organizations

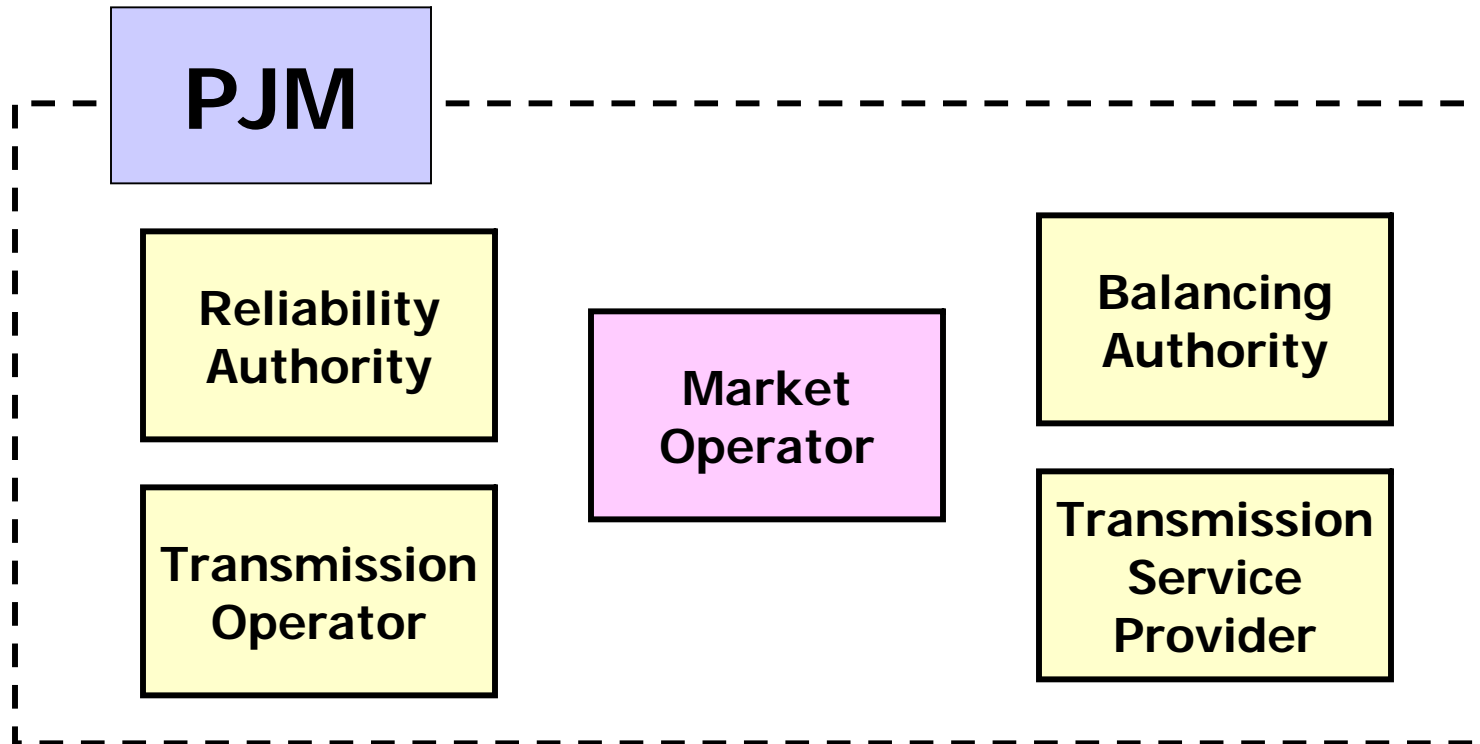

"Rolling Up" into Organizations

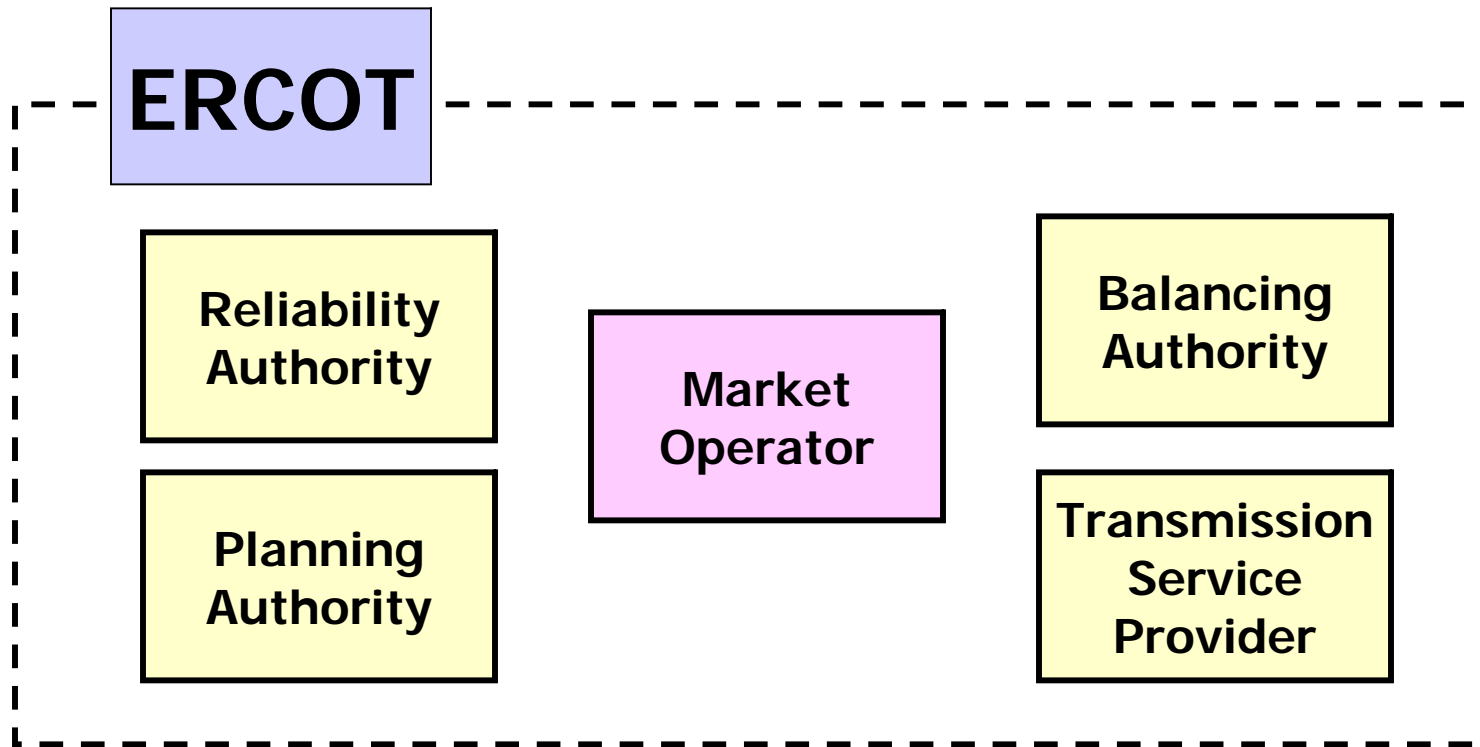

"Rolling Up" into Organizations

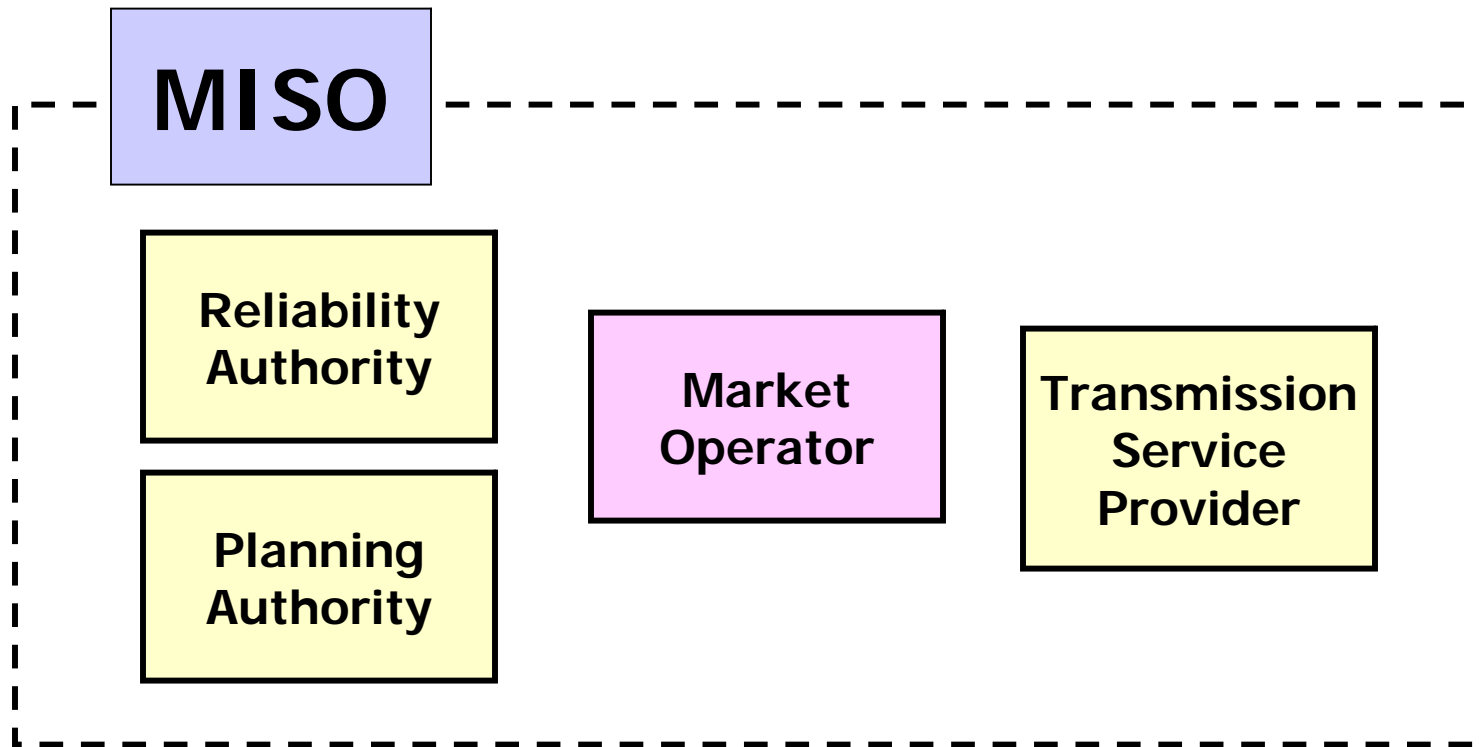

Questions?

